

“AMF” - MIXED FLOW DUCT FANS

Installation Instructions



- for toilets, bathrooms and utility rooms
- suitable for installation in
 - wall
 - window
 - ceiling
- 3 models
 - pull cord/remote
 - timer
 - humidity control
- 3 Low Voltage (SELV) models
 - pull cord/remote
 - timer
 - humidity control

PLEASE READ THE FOLLOWING INSTRUCTIONS VERY CAREFULLY BEFORE INSTALLING THE PRODUCT.

THE RANGE

AMF100C, AMF100CLV - pull cord operated/or remote switching after cutting off cord

AMF100T, AMF100TLV - with adjustable overrun timer - these fans should be operated by a remote switch which can also be used to control the room light. After the light/fan is switched off the fan will continue to run for the pre-set length of time.

AMF100HCT, AMF100HCTLV - with humidistat and timer - the adjustable, electronic humidistat is pre-set so that the fan will operate automatically when the moisture content in the room reaches 70% R.H. The fan will continue to operate until the Relative Humidity falls below the pre-set level and the timer has completed the over-run period. The fan can be operated by the pull cord (or by a remote switch) independently of the humidistat (a neon light indicates that the fan is operating in this mode). NOTE: the fan will continue to operate for a short period after the cord is pulled a second time, i.e. until the humidistat senses that the relative humidity in the room has fallen beneath the pre-set level and the timer has completed its overrun period.

All versions with "LV" are LOW VOLTAGE (SELV). They MUST be installed with the transformer provided.

All versions with Timer or Humidistat incorporate adjustable trimmers. The overrun period on timer can be adjusted upwards by turning the RED trimmer on the PC Board in a clockwise direction (from a minimum of 3 to a maximum of 15 minutes). The Humidistat can be adjusted so that it starts to operate at a higher level of relative humidity by turning the BLUE trimmer in a clockwise direction (from a minimum of 40% to a maximum of 100%).

All versions with Humidistat incorporate a controlled temperature set-back allowing the humidistat to take into account variations in the ambient temperature and to avoid the fan switching on unnecessarily. This reduces fan operation at night.

All the fans (with the exception of the "LV" models) are splash proof to standard IPX4. The "LV" fans are rated IP57 enabling them to be safely installed in areas where a splash proof fan does not provide sufficient protection against water ingress (the transformer must **not** be installed where it could be splashed)

All the fans are extremely quiet in operation.

IMPORTANT - SITING INFORMATION

1. For optimum use your fan should be installed at a minimum height of 2.3 m.
2. The fan must not be used in an ambient temperature higher than 40°C.
3. Your fan should not be exhausted into a duct which is already used for any other purpose.
4. An adequate supply of fresh air must be provided if the fan is to be fitted in a room containing a fuel burning appliance which is not of the balanced flue type.
5. Installation must be carried out by qualified personnel. Incorrect installation can cause damage to people, animals or property for which the manufacturer cannot be held liable.
6. If you have any doubts concerning this product, please contact your supplier.

IMPORTANT - ELECTRICAL INFORMATION

1. All electrical connections must comply with current BS7671 wiring regulations.
2. The fan is a fixed appliance, and the electrical supply must therefore be by a fixed wired and fused (3 amp) spur incorporating a double pole switch with contact openings of at least 3 mm. Use twin conductor cable of at least 1 mm in section.
3. Your fan is double insulated and does not require earthing.
4. The fans comply with BSEN60335; with the Low Voltage Directive; with EC Directive EMC 89/336 for the Suppression of Radio Interference.

Electrical Information cont

5. It is recommended that the installation be carried out by a qualified electrician.
6. The printed circuit board in these fans has been protected to make it compatible with the majority of fluorescent fittings available on the market today. However, it is impossible to be aware of all the new products introduced. We suggest therefore that you contact your supplier to establish the compatibility of the fluorescent fitting you intend to use.

INSTALLATION INSTRUCTIONS

Preparation

1. Remove all packing material and check that your fan has not been damaged in transit.
2. Check that your electrical voltage and frequency correspond with those marked on the rating label.
3. Check the location of existing wiring for ease of connection.
4. Cut a 4"/10 cm hole (plus thickness of ducting to be used, when necessary) on the wall, ceiling or window.
5. Make the electrical connections as in the following instructions.

Fixing Instructions

1. Loosen the single screw located in the lower edge of the casing, and remove the front cover by pulling forward and upward.
2. **How to install in a wall** - using the template provided, mark 4 holes in the wall, drill and fit wall plugs. Fix the main body of the fan to the wall using 4 screws locating them through the holes at each corner. Ensure that the fixing surface is flat in order to avoid distortion of the casing when the fixing screws are tightened. If using Wall Vent Kit, secure flexi-duct to spigot of fan and spigot of grille. Fix grille to outside wall through 4 holes located in corners.
3. **How to install in a ceiling** - if installing fan into plasterboard ceiling put spigot of fan through hole and secure using Ceiling Ring. If the ceiling is of thicker construction follow wall installation instructions above.
4. **How to install in a window** - separate the locking ring by unclipping it from the grille section of the Window Kit. Remove backdraught shutter from the fan. Put the fan through the hole already cut in window and screw the locking ring on to fan spigot securing it firmly. Clip back on the central flange/outer grille to the locking ring ensuring it lines up with the inside part of the fan. N.B.: By following the above instructions, the fan can be installed with the Double Glazing Window Kit after the hole has been cut and sealed by the manufacturer.
5. Connect the incoming wiring supply as indicated in "Wiring Instructions" below.
6. Replace the front cover by first locating the top edge of the cover over the top edge of the main body and then hinge the cover downwards.
7. Lock the cover in place by tightening the screw on the lower edge.

WIRING INSTRUCTIONS

1. Ensure that the mains electrical supply is switched off during the installation of the fixed wiring spur.
2. Read carefully "Important-Electrical Information" above.
3. Connect as shown in the Wiring Diagrams below.

AMF100C with Remote Switch
Pull cord to ON position and cut off

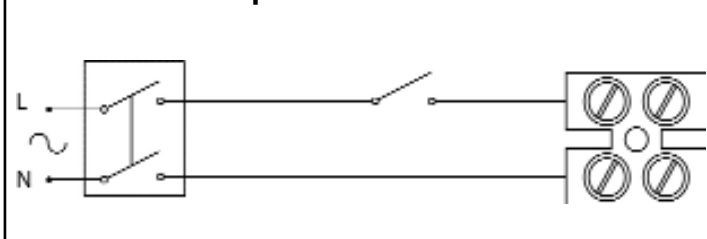

AMF100C

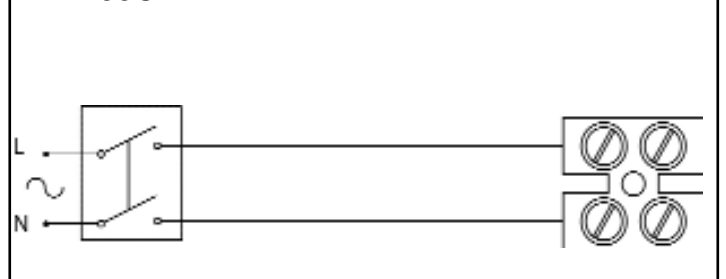

Wiring Instructions cont

AMF100HCT (cord operated)

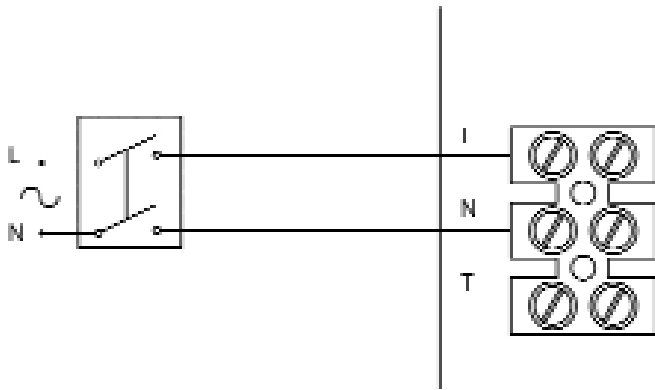

AMF100T & *AMF100HCT

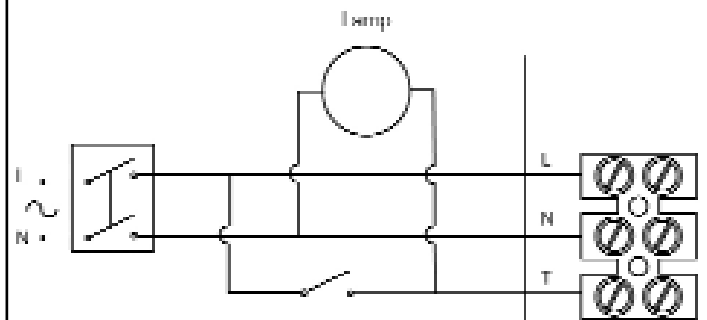

*AMF100HCT can be wired for remote switching - ensure pull cord switch is in **OFF** position and remove cord

AMF100CLV

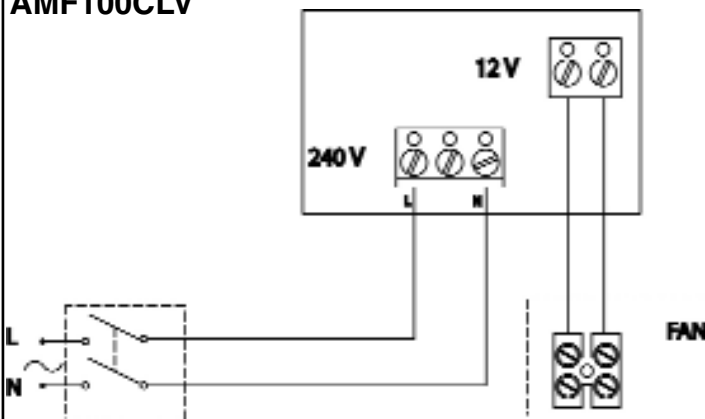

AMF100LV

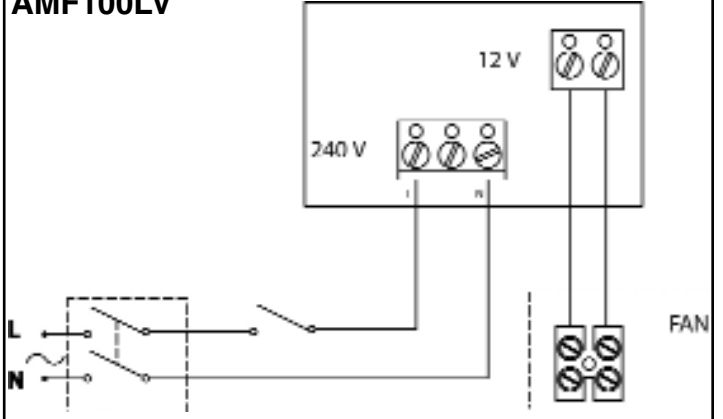

AMF100TLV

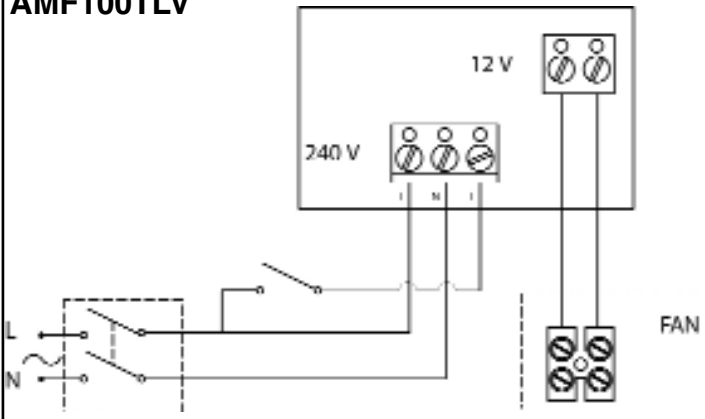

AMF100HCTLV

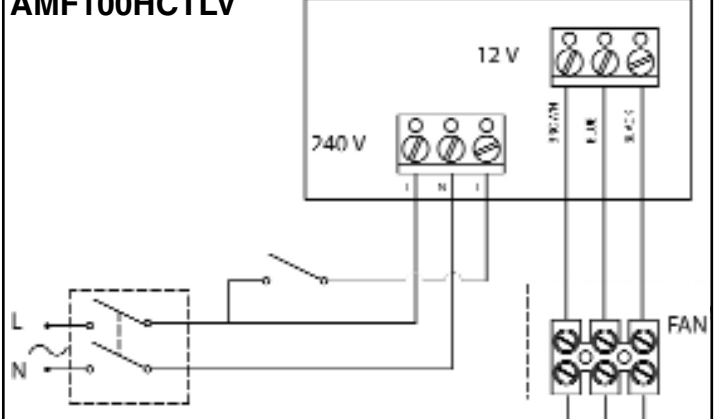

CLEANING & MAINTENANCE

1. Disconnect mains electrical supply by means of double pole switch.
2. Remove front grille (A) as described above and wash with mild detergent.
3. To clean the inner part of the fan, use a soft brush taking care not to cause any damage or disturb the electrical wiring.

ACCESSORIES

Ceiling Ring - for ceiling installation

Wall Vent Kit - comprises 14" length of flexible duct and gravity grille for outside wall.

Window Kit - necessary for installation of fans into single or double glazed windows up to 20 mm.

Vectaire Ltd, Lincoln Road, Cressex Business Park, High Wycombe
Buckinghamshire, HP12 3RH

Tek: +44(0)1494 522333. Fax: +44(0)1494 522337

Email: sales@vectaire.co.uk. Web: www.vectaire.co.uk